

For the circuit below, find v_{R4} . Give some thought to which analysis method you choose to use.

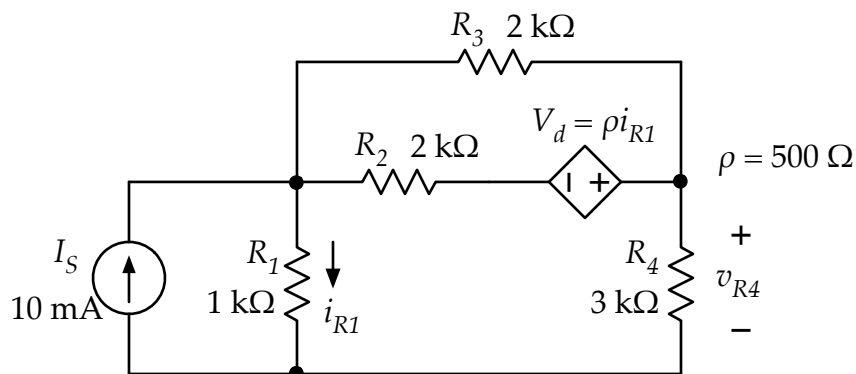

$v_{R4} =$ _____